

# LIGHTIDE



OUTDOOR | COMMERCIAL | EMERGENCY

LED Lighting Solution Supplier to North America!

# We are a DLC qualified LED Lighting Manufacturer



## About Lightide

Lightide Manufactory Co., Ltd. focuses on the lighting industry for over 20 years. We designed and produced several varieties of commercial & outdoor LED light fixtures. Till now, we have provided service to more than 200 companies from 19 countries.

**LIGHTIDE**

LIGHTIDE MANUFACTORY CO., LTD.,

(FS BRANCH)

深圳莱泰德科技有限公司

# Why Choose Us

▶ **01.**

## Flexible Solution

Provide you peace of mind by providing you with customized LED fixtures and flex solutions.



**02.**

## Quality Made

Quality-made components that are built to last plus reliable LED technologies to help lower energy bills.

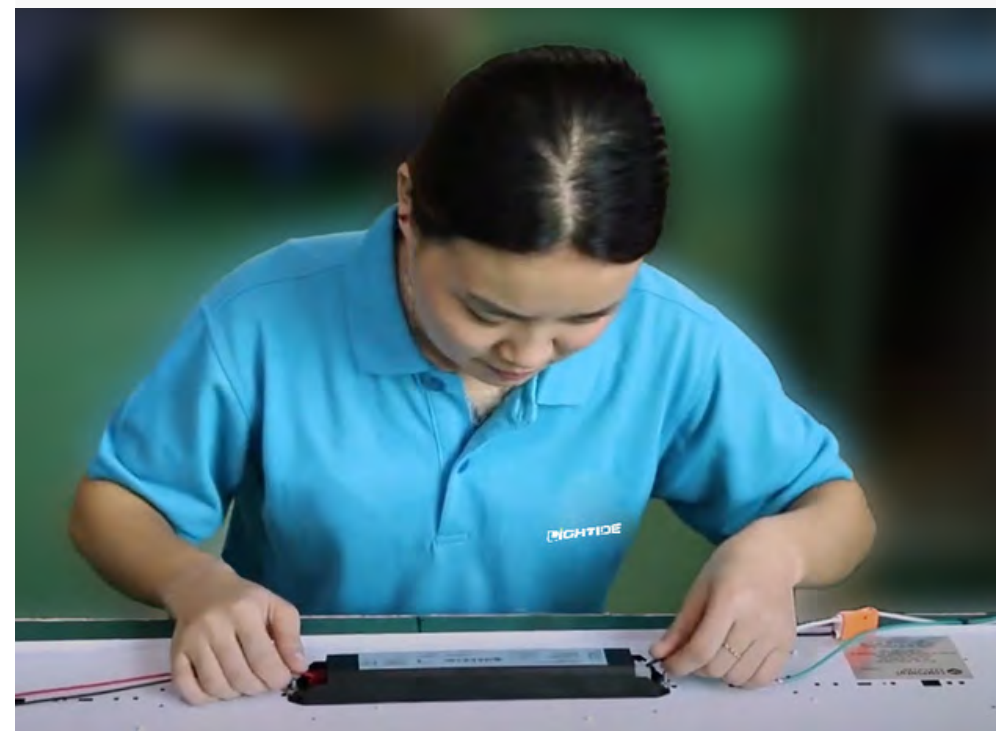

**03.**

## Strict Inspection

Conducts strict inspections and manufacture according to American UL standards and European IEC standards.



OUTDOOR | COMMERCIAL | EMERGENCY

# Certificate

Lightide's products undergo rigorous quality and safety testing. As a result, we are offering the best indoor & outdoor led lighting products. And all of them meet all appropriate certifications to the market at all times.

www.lightideled.com | sales@lightideled.com

This authorizes the application of the Certification Mark(s) shown below in the Product(s) Covered section when made in accordance with the conditions set forth in the Certification Agreement and Listing Report. This authorization also applies to multiple listee model(s) identified on the correlation page of the Listing Report.

This document is the property of Intertek Testing Services and is not transferable. The certification mark(s) may be applied only at the location of the Party Authorized To Apply Mark.

**Applicant:** Lightide HK Industrial Co., Limited      **Manufacturer:** Lightide Manufactory Co., Ltd

**Address:** Unit 04, 7/F, Bright Way Tower #33 Mong Kok Road, Kowloon      **Address:** Building 10, Gongchai Industrial Area, Baoan District, Shenzhen 518125, China

**Country:** Hongkong      **Country:** China

**Contact:** Jack Li      **Contact:** Andy Wu

**Phone:** +852-2793-5511      **Phone:** +86 755 83837000

**FAX:** --      **FAX:** --

**Email:** lightideled@gmail.com      **Email:** info@lightide-tech.com

**Party Authorized To Apply Mark:** Same as Manufacturer  
**Report Issuing Office:** Intertek Testing Services Hong Kong Limited

**Control Number:** 5003657      **Authorized by:**  for Dean Davidson, Certification Manager



This document supersedes all previous Authorizations to Mark for the noted Report Number.

This Authorization to Mark is for the exclusive use of Intertek's Client and is provided pursuant to the Certification agreement between Intertek and its Client. Intertek's responsibility and liability are limited to the terms and conditions of the agreement. Intertek assumes no liability to any party, other than to the Client in accordance with the agreement, for any loss, expense or damage occasioned by the use of this Authorization to Mark. Only the Client is authorized to permit copying or distribution of this Authorization to Mark and then only in its entirety. Use of Intertek's Certification mark is restricted to the conditions laid out in the Authorization to Mark. Any further use of the Intertek name for the sale or advertisement of the tested material, product or service must first be approved in writing by Intertek. Initial Factory Assessments and Follow up Services are for the purpose of assuring appropriate usage of the Certification mark in accordance with the agreement, they are not for the purposes of production quality control and do not relieve the Client of their obligations in this respect.

Intertek Testing Services NA Inc.  
 545 East Algonquin Road, Arlington Heights, IL 60005  
 Telephone 800-345-3851 or 847-439-5667 Fax 312-283-1672

<b>Standard(s):</b>	Standard for Safety for Luminaires - UL 1598, Issued: 2008/09/17 Ed:3 Rev: 2012/10/17
	Standard for Safety for Luminaires - CSA C22.2 No. 250.0 Issued: 2008/09/17 Ed: 3 (R2013)
<b>Product:</b>	LED fixed luminaire
<b>Brand Name:</b>	<b>LIGHTIDE</b>

product ID: PEF6WUSF



**LT-WP01-60W-50K**

**Manufacturer:** Lightide (HK) Industrial Co, Limited

**Brand:** Lightide

PRODUCT OVERVIEW		PRODUCT INFORMATION	
<b>Classification</b>	Standard	<b>Qualified Product List</b>	Solid State Lighting
<b>Primary Use</b>	Outdoor Non-Cutoff and Semi-Cutoff Wall Mounted Area Luminaires	<b>Technical Requirements Version</b>	5.0
<b>Reported Input Wattage</b>	57 W	<b>Product ID</b>	PEF6WUSF
<b>Reported Light Output</b>	7200 lm	<b>Manufacturer</b>	Lightide (HK) Industrial Co, Limited
<b>Reported CCT</b>	5000 K	<b>Brand</b>	Lightide
<b>Reported CRI (Ra)</b>	73	<b>Model Number</b>	LT-WP01-60W-50K
<b>Product ID</b>	PEF6WUSF	<b>Parent</b>	No
<b>DLC Family Code</b>	WWWERC	<b>Classification</b>	Standard
<b>Listing Status</b>	Listed	<b>PRODUCT CATEGORIZATION</b>	
<b>Date Qualified</b>	2017-06-12	<b>PRODUCT CAPABILITIES</b>	
		<b>REPORTED PHOTOMETRIC PERFORMANCE</b>	
		<b>REPORTED ELECTRICAL PERFORMANCE</b>	
		<b>VERSION HISTORY</b>	



## 发明专利证书

Certificate of Invention Patent

中华人民共和国国家知识产权局  
 STATE INTELLECTUAL PROPERTY OFFICE OF THE PEOPLE'S REPUBLIC OF CHINA

TPW05W

**LT-PTB50-50K**

**Manufacturer:** Lightide (HK) Industrial Co, Limited

**Brand:** Lightide

PRODUCT INFORMATION	
<b>Qualified Product List</b>	Solid State Lighting
<b>Technical Requirements Version</b>	5.0
<b>Product ID</b>	TPW05W
<b>Manufacturer</b>	Lightide (HK) Industrial Co, Limited
<b>Brand</b>	Lightide
<b>Model Number</b>	LT-PTB50-50K
<b>Parent ID</b>	---
<b>Classification</b>	Standard

**CERTIFICATE**  
of Conformity  
EC Council Directive 2006/95/EC

Registration No.: DGS 09060122

**Applicant:** Lightide HK Industrial Co., Limited  
 Unit D, 16/F., Cheuk Nang Plaza 250, Hennessy Road, Wanchoi HK

**Product:** LED High Bay Light

**Identification:** Model No.: LT-HB40-30W, LT-HB40-40W, LT-HB40-50W, LT-HB40-60W, LT-HB40-70W, LT-HB40-80W, LT-HB40-90W, LT-HB40-100W, LT-HB45-120W, LT-HB120-30W, LT-HB120-40W, LT-HB120-50W, LT-HB120-60W, LT-HB120-70W, LT-HB120-80W, LT-HB120-90W, LT-HB120-100W, LT-HB120-120W

**Serial No.:** N/A

**Rating:** AC100-240V 50/60Hz, 120W Max

**Standards:** EN 60598-2-1:1998 and EN 60598-1:2008 + A11:2009, EN 61347-1:2008 and EN 61347-2-13:2006

The certificate of conformity is based on an evaluation of a sample of the above-mentioned product. Technical report and documentation are at the applicant's disposal. This is to certify that the tested sample is in conformity with all provisions of Annex I of Council Directive 2006/95/EC, referred to as the Low Voltage Directive. This certificate does not imply assessment of the production and does not permit the use of CE Marking. The applicant of the certificate is authorized to use this certificate in connection with the EC declaration of conformity according to Annex II of the Directive.

Certified by  
  
Peter Zhu

June 2, 2009  
Date

CE  CE

ACCURETE TECHNOLOGY CO., LTD. - Research & Industry Park of ATL No. 145, Shama Street, Shama Road, Hongkong, Telephone: 8522668, Fax: 8522669, E-mail: atl@atlab.com



## 实用新型专利证书

Certificate of Utility Model Patent

OUTDOOR | COMMERCIAL | EMERGENCY

# Successful Cases



# LED Canopy Light

LED canopy lights are vandal-proof and DLC premium, which are suitable for gas stations, parking lots, etc.



## Surface Mount / SGSAL Series

- UL924 & CEC Title-20 Compliant
- NFPA101 Compliant
- Intelligent emergency detection function
- Vandal Proof
- Excellent Performance – 120 lumens per watt
- 5-year Warranty – No-compromise warranty covered.
- Listings –DLC premium, ETL/cETL , CE/RoHS.



## LT-WP01 Series

- High Duty Die-casting Aluminum
- Excellent Efficacy – 140 lumens per watt
- UL924 , CEC Title-20 & NFPA 101 Compliant
- 5-Year Warranty
- Listings -DLC Qualified, ETL/cETL, CE/RoHS
- Wire guard & Dark Sky Compliant Shield are available



Dark Sky Compliant Shield

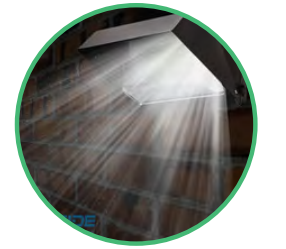

Tempered Glass



Emergency Backup



# LED Wall Pack

LED wall pack lights can be built with a photocell for security lighting, which is mounted on the wall.

# LED Post Top

LED lights are installed on top of poles and have a Type III, Type IV, or Type V that lights up the area.



## LT-PTB Series

- Excellent Performance – 140 lumens per watt.
- LED Module Design- Type II
- Easy Installation – suitable for 2.4" or 3" pole mounted
- The one-piece-die-casting aluminum frame or housing.
- 5-year Warranty – No-compromise warranty covered.
- Listings: DLC QPL, ETL/cETL, CE/RoHS



## LT-UBA Series



Factory-Assembly (EM)

Field-Assembly (EMH)

- High Efficacy – 140~160 lumens per watt
- Bi-level Microwave motion sensor available
- Zigbee or Bluetooth smart control available
- Emergency Mode
- UL924 & CEC Title 20 Compliant
- Factory Assembly: No additional labor costs
- Charge cycle: >500 times
- Work Temp. -22°F~+122°F (-30°C~50°C).
- Test switch + Indicator lamp



# LED High Bay

Lightide provides high energy-efficient led lights with UFO style, linear style, and emergency backup

Linear LED Garage Lights 4ft feature power selectable ranges of 32-44-50 watts and CCT selectable ranges of 3000K-4000K-5000K. And they also are built with a 1-10vdc dimming and motion sensor. Therefore, these high bay garage led lights are powerful lighting in harsh environments, protecting the light source from dust and moisture



32W-44W-50W Selectable  
3000K-4000K-5000K Selectable

### LT-TPA436CP(T)

1. Excellent Performance - up to 150 lumens per watt.
2. Selectable Power Range from 32W-44W-50W in one fixture.
3. Selectable CCT Range from 3000K-4000K-5000K
4. Emergency Battery Backup is available.



Selectable  
Switch



Motion Sensor



Emergency  
Backup



- 32W-44W-50W Selectable
- 40W-50W-60W Selectable
- 3000K-4000K-5000K Selectable

### LT-VTA440CP(T) LT-VTA450CP

1. Up to 130 lumens per watt
2. Selectable Power Range from 32W-40W-50W or 40W-50W-60W.
3. Selectable CCT Range from 3000K-4000K-5000K
4. Bi-level Motion Sensor with ON/OFF and 3-step dimming.
5. J-BOX Mount kits
6. 165x120 deg. beam angle

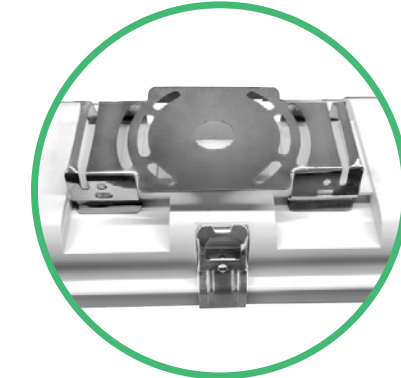

J-Box Mount

## Power & CCT Selectable

These LED lighting fixtures are allowed 3 different wattage and CCT settings with two simple slide switches.

OUTDOOR | COMMERCIAL | EMERGENCY

# Facility



PRODUCTION



SMT



WELDER



SAFETY STANDARD TEST

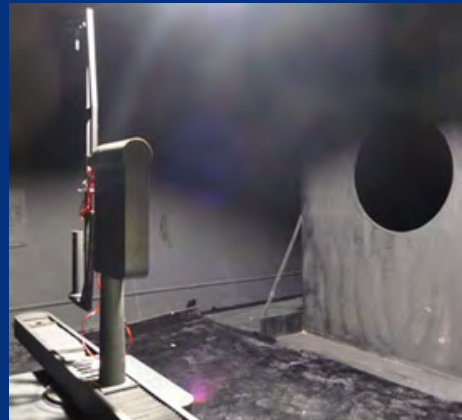

DISTRIBUTION PHOTOMETER

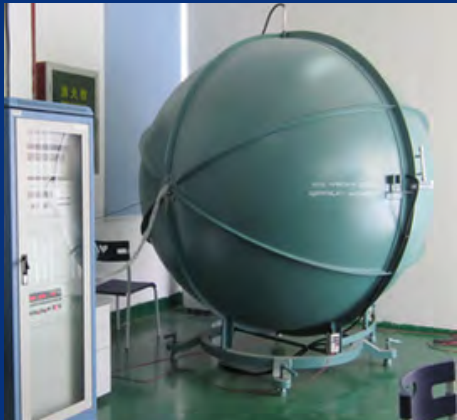

INTEGRATING SPHERE



LASER CUTTING



STAMPING



DIE-CASTING

OUTDOOR | COMMERCIAL | EMERGENCY

# Our Partner





**Mary , USA**

Purchase Manager

OUTDOOR | COMMERCIAL | EMERGENCY

# What our customers say

Really like these fixtures. Not only did they're installed go well. In conclusion, they made me really appreciate how great the canopy fixture really is.

OUTDOOR | COMMERCIAL | EMERGENCY

# Contact Us



+86 755 8383 7000



[sales@lightideled.com](mailto:sales@lightideled.com)



[www.lightideled.com](http://www.lightideled.com)



[View more detail.](#)

