



AREA & SITE LED FLOOD LIGHT



Lightide Industrial — 1999

YOUR STREET
LIGHTING,
PARKING LOT &
FLOOD LIGHTING
PARTNERR

20

YEARS

LED lighting industry

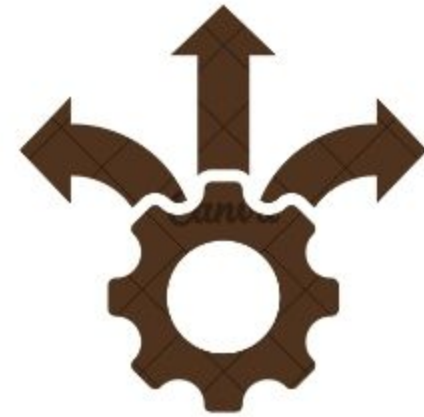

FLEXIBLE SOLUTION

Your satisfaction is our top priority.





INTRODUCTION

This presentation will walk through LED Lights for your business

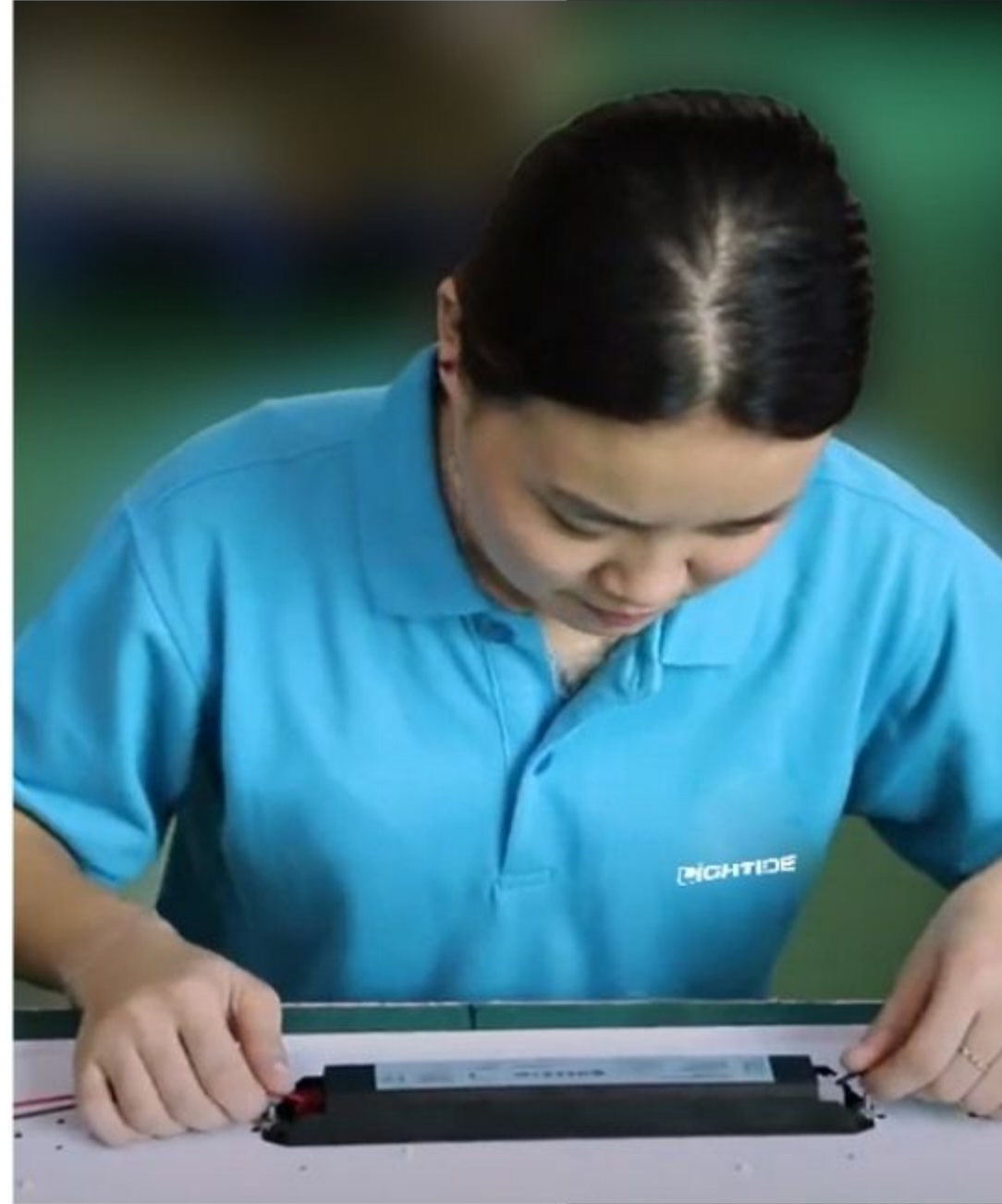

QUALITY MADE

High-duty Die-casting aluminum alloy case and shatter-proof cover



LONG TERM WARRANTY

Sell and back them with an excellent 5-10 years warranty



FAST US SHIPPING

Get your lights fast and keep your project on schedule

ABOUT PRODUCTS

Led parking lot lights feature CCT & wattage selectable with high efficacy alternatives to MH area lights and street lights. Moreover, these led street lights feature Type , II, III, Type IV, and Type V distribution that lights up the area for parking lots, pathways, sidewalks, street lighting, etc.



EXCELLENT PERFORMANCE

Premium LM80 certified LED chips output high efficacy to save 80% electricity cost.



CCT & WATTAGE SELECTABLE

This flexible choice capability allows to reduce stocking inventory by 88%.



OCC. MOTION SENSOR

Turn on the LED light fixtures when motion is detected to save more energy cost.

OVERVIEW

02

About Us

06

Wall Mount
LED Flood Light

08

Pole Mount
LED Flood Light

13

Parking Lot
LED Flood Light

17

Stadium Lighting
LED Flood

19

Choice Guide





HALF CUTOFF LED WALL PACK



- Excellent Efficacy – 140 lumens per watt
- Std. 1-10vdc Dimming
- High-duty die-casting aluminum alloy
- Tempered glass/ PC diffuser options
- IP65 Rated
- Dark Sky Compliant Shield
- Emergency Backup is available.



DARK SKY
SHIELD

EMERGENCY
BACKUP

| Com. | Series | Rated | Voltage | CCT | Option | Finish |
|------|--------|-----------------------------------|------------------|-------------------------|--------------|--------------|
| LT | WPO1 | 40W | Blank=100-277vac | 30K =3000K | DM=1-10VDC | Blank=Bronze |
| | | 60W | HV =200-480vac | 40K=4000K | PC=Photocell | BK= Black |
| | | 90W | | 50K=5000K | MS=Motion | |
| | | 120W | | 57K= 5700K | | |
| | | 60WCPC = 36W-48W -56W Selectable | | T= 30K-40K- 50K Select. | | |
| | | 120WCPC=72W-100W -120W Selectable | | | | |
| | | | | | | |



FULL CUTOFF

LED WALL PACK



- Wide Input Voltage – 100-277 or 120~347vac
- Excellent Efficacy – 140 lumens per watt
- Beam Angle: Type III
- 5-Year Unlimited Warranty
- Listings –DLC certified, ETL/cETL, CE/RoHS
- Emergency Battery Backup is available.
- Work Temperature: -40°F ~+140°F



DARK SKY SHIELD



EMERGENCY BACKUP

| Com. | Series | Rated | Voltage | CCT | Option | Duration (EM) | Finish |
|------|--------|-------|------------------|------------|--------------|---------------|--------------|
| LT | WPCA | 35W | Blank=100-277vac | 30K =3000K | DM=1-10VDC | STD.=90MIN. | Blank=Bronze |
| | | 60W | HV =200-480vac | 40K=4000K | PC=Photocell | 2H=120MIN. | WH=White |
| | | 80W | | 50K=5000K | MS=Motion | 3H=180MIN. | |
| | | 100W | | 57K= 5700K | EM=Emergency | | |
| | | 120W | | | | | |



ROUND STYLE

LED POST TOP



- 130~140 lumens per watt.
- Wattage & CCT selectable
- Unique diffuser design and shatter-proof lens
- LED Distribution- Type V
- Easy Installation – suitable for 2 3/8" or 3" pole mounted
- High-duty die-casting aluminum housing.
- Folding design to reduce the freight
- IP65 rated



FOLDING DESIGN



MOTION SENSOR

| Com. | Series | Rated | Voltage | CCT | Option | Finish |
|------|--------|--------------------------------|------------------|----------------|--------------|--------------|
| LT | PTA | 30=30W | Blank=100-277vac | 30K =3000K | DM=1-10VDC | Blank=Bronze |
| | | 50=50W | HV =200-480vac | 40K=4000K | PC=Photocell | BK= Black |
| | | 60=60W | | 50K=5000K | MS=Motion | |
| | | 80=80W | | 57K= 5700K | | |
| | | 100=100W | | T= 30K-40K-50K | | |
| | | 150=150W | | Selectable | | |
| | | 60CP= 30W-50W -60W Selectable | | | | |
| | | 100CP=60W-80W -100W Selectable | | | | |



NON
DIFFUSER



FROSTY
DIFFUSER

COLONIA STYLE

LED POST TOP



- 100~120 lumens per watt.
- Wattage & CCT Selectable
- LED Distribution- Type III, IV, and V for options
- Easy Installation – suitable for 2 3/8" or 3" pole mounted
- The one-piece-die-casting aluminum frame or housing.
- Polycarbonate or glass diffuser for options
- std. Black finish
- IP65 Rated



| Com. | Series | Rated | Voltage | CCT | Option | Diffuser |
|------|--------|---------------------------------|------------------|---------------------------|---------------------|--------------|
| LT | PTB | 30=30W | Blank=100-277vac | 30K =3000K | DM=1-10VDC | Blank=Frosty |
| | | 50=50W | HV =200-480vac | 40K=4000K | PC=Photocell | CR= Clear |
| | | 60=60W | | 50K=5000K | | |
| | | 80=80W | | 57K= 5700K | | |
| | | 50CP=30W-50W- 80W Selectable | | T= 30K-40K-50K Tunable | MS=Motion Sensor | |
| | | 100=100W | | | | |
| | | 120=120W | | | | |





ACORN STYLE

LED POST TOP



- 100~120 lumens per watt.
- Wattage & CCT Selectable
- LED Distribution- Type V
- Easy Installation – suitable for 3" pole mounted
- High-duty die-casting aluminum housing.
- Polycarbonate or acrylic diffuser option
- IP65 Rated



| Com. | Series | Rated | Voltage | CCT | Option | Diffuser |
|------|--------|-------------------------------|------------------|------------|------------------------|------------------|
| LT | PTF | 30=30W | Blank=100-277vac | 30K =3000K | DM=1-10VDC | Blank=Frosty |
| | | 50=50W | HV =200-480vac | 40K=4000K | PC=Photocell | CR= Clear |
| | | 60=60W | MV =120-347vac | 50K=5000K | | |
| | | 80=80W | | 57K= 5700K | | |
| | | 100=100W | | | | |
| | | 60CP=30W-50W-60W Selectable | | | T= 30K-40K-50K Tunable | MS=Motion Sensor |
| | | 100CP=60W-80W-100W Selectable | | | | |





STH SERIES

LED STREET LIGHT



- 140 lumens per watt.
- LED Module Design- Type II & III
- Zhaga photocontrol
- 5-year Warranty
- Waterproof Rated: IP65
- High-duty die-casting aluminum alloy case
- Safety-Open design- Safe maintenance function
- Suitable for the pole with DIA. 40mm~60 mm

| Com. | Series | Rated Power | Voltage | CCT | Option | Beam Angle |
|------|--------|-------------|------------------|------------|------------|--------------|
| LT | STH | 030 =30W | Blank=100-277vac | 30K =3000K | DM=1-10VDC | T2= TYPE II |
| | | 080 =80W | | 50K=5000K | | T3= Type III |
| | | 100 =100W | | 57K= 5700K | | |
| | | 120 =120W | | | | |
| | | 150 =150W | | | | |
| | | 180 =180W | | | | |
| | | 200=200W | | | | |



ZHAGA
PHOTOCELL



OPEN SAFETY
PROTECTION



STL SERIES

LED STREET LIGHT



- 140 lumens per watt.
- LED Module Design- Type III
- Zhaga photocontrol
- 5-year Warranty
- Waterproof Rated: IP66
- High-duty die-casting aluminum alloy case
- Safety-Open design- Safe maintenance function
- Suitable for the pole with DIA. 40mm~60 mm



| Com. | Series | Rated Power | Voltage | CCT | Option | Beam Angle |
|------|--------|-------------|------------------|------------|------------|-----------------|
| LT | STH | 080 =80W | Blank=100-277vac | 30K =3000K | DM=1-10VDC | Blank= Type III |
| | | 100 =100W | | 50K=5000K | | |
| | | 150 =150W | | 57K= 5700K | | |
| | | 250 =250W | | 40K=4000K | | |
| | | 300 =300W | | | | |





SBAL

LED PARKING LOT



- 135~150 lumens per watt.
- High-duty die-casting aluminum alloy case
- New Up-Down Penetrative heat sink design
- Shatter proof lens
- Light Distribution: Type III, IV, V
- Built-in 10KV surge protection
- 5~10 Years Warranty
- IP65 rated



PHOTOCELL



MOTION SENSOR

| Com. | Series | Rated Power | Voltage | CCT | Option | Beam Angle |
|------|--------|-------------|------------------|------------|------------------|--------------|
| LT | SBAL | 25=25W | Blank=100-277vac | 30K =3000K | DM=1-10VDC | T3= TYPE III |
| | | 50=50W | HV =200-480vac | 40K=4000K | PC=Photocell | T4= TYPE IV |
| | | 100=100W | | 50K=5000K | | T5= Type V |
| | | 150=150W | | 57K= 5700K | | 30D=30 Deg. |
| | | 200=200W | | | MS=Motion Sensor | 60D=60 Deg. |
| | | 240=240W | | | | |
| | | 300=300W | | | | |
| | | 400=400W | | | | |
| | | 500=500W | | | | |



MOUNT ADAPTER

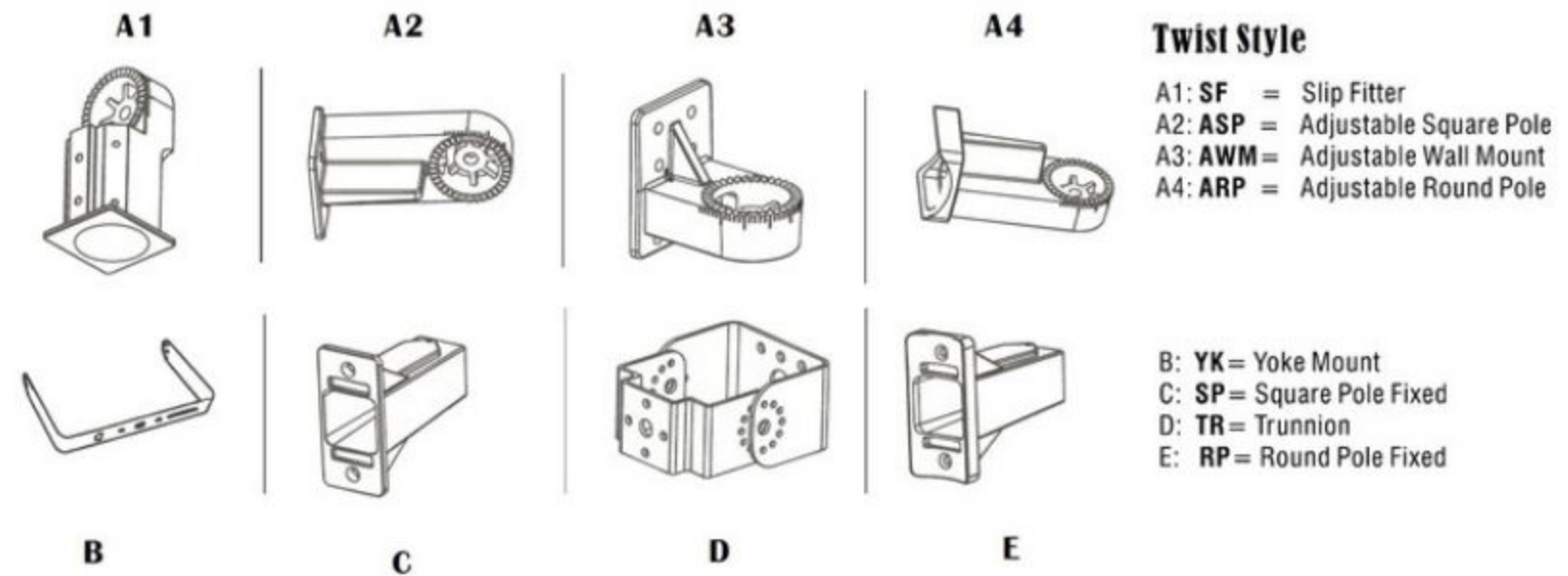

LED Area Light Adapter Option





PHOTOCELL



SLIP FITTER

SBAL-C SERIES

LED PARKING LOT



- 135~150 lumens per watt.
- High-duty die-casting aluminum alloy case
- New Up-Down Penetrative heat sink design
- Shatter proof lens
- Light Distribution: Type II, III, V
- Built-in 10KV surge protection
- 5~10 Years Warranty
- IP65 rated



| Com. | Series | Rated Power | Voltage | CCT | Option | Beam Angle |
|------|--------|-------------|------------------|------------|------------------|--------------|
| LT | SBAL | 100C=100W | Blank=100-277vac | 30K =3000K | DM=1-10VDC | T3= TYPE III |
| | | 150C=150W | HV =200-480vac | 40K=4000K | PC=Photocell | T2= TYPE II |
| | | 200C=200W | | 50K=5000K | MS=Motion Sensor | T5= Type V |
| | | 250C=250W | | 57K= 5700K | | |
| | | 300C=300W | | | | |





PHOTOCELL



CCT & WATTAEG
SELECTABLE

STPL

LED PARKING LOT



- 130~140 lumens per watt.
- High-duty die-casting aluminum alloy case
- Slim style
- Shatter proof lens
- Light Distribution: Type III, IV, V, 30 Deg., 60 Deg.
- Built-in 10KV surge protection
- 5~10 Years Warranty
- IP65 rated



| Com. | Series | Rated Power | Voltage | CCT | Option | Beam Angle |
|------|--------|----------------------------------|------------------|-----------------------------|---------------------|--------------|
| LT | STPL | 050 =50W | Blank=100-277vac | 30K =3000K | DM=1-10VDC | T3= TYPE III |
| | | 100 =100W | HV =200-480vac | 40K=4000K | PC=Photocell | T4= TYPE IV |
| | | 150 =150W | | 50K=5000K | | T5= Type V |
| | | 200 =200W | | 57K= 5700K | | 30D=30 Deg. |
| | | 150CP=100W-150W- 200W Select. | | CTS=30K-40K- 50K Select. | MS=Motion Sensor | 60D=60 Deg. |
| | | 240 =240W | | | | |
| | | 300 =300W | | | | |
| | | 240CP=200W- 240W-300W Select. | | | | |
| | | | | | | |
| | | | | | | |





HPSF

LED STADIUM LIGHT



- Excellent Performance – 130~140 lumens per watt.
- Ultra-Slim Profile
- High-duty die-casting aluminum alloy case
- Tempered glass cover
- Premium Chip – Philips Chip
- RGB/RGBW (DMX512) control available
- Surge Protection – Separate 10KV surge protection device to avoid early failure
- Unique Lens Design: 10/30/60/85×135 deg.
- 5 years Warranty
- Listings– ETL/cETL, CE & RoHs, TUV, CB, FCC and SAA



| Com. | Series | Rated | Voltage | CCT | Option | Beam Angle |
|------|--------|-------|------------------|------------|----------------------|-----------------|
| LT | HPSF | 400W | Blank=100-277vac | 30K =3000K | DM=1-10VDC | ASY=85X135 deg. |
| | | 600W | HV =200-480vac | 40K=4000K | SPD=Surge Protection | 30D=30 deg. |
| | | 800W | | 50K=5000K | | 60D=60 deg. |
| | | 1000W | | 57K= 5700K | | 10D=10 deg. |
| | | 1200W | | RGB | | |





HPRF

LED STADIUM LIGHT



- Excellent Performance – 120~130 lumens per watt.
- Ultra-Slim Profile
- High-duty die-casting aluminum alloy case
- Tempered glass cover
- Premium Chip – CREE/Philips Chip
- Surge Protection – Separate 10KV surge protection device to avoid early failure
- Unique Lens Design: 15/30/60 deg.
- 5 years Warranty
- Listings– ETL/cETL, CE & RoHs, TUV, CB, FCC and SAA



| Com. | Series | Rated | Voltage | CCT | Option | Beam Angle |
|------|--------|-------|------------------|------------|----------------------|--------------|
| LT | HPRF | 300W | Blank=100-277vac | 30K =3000K | DM=1-10VDC | 15D =15 deg. |
| | | 400W | HV =200-480vac | 40K=4000K | SPD=Surge Protection | 30D=30 deg. |
| | | 500W | | 50K=5000K | | 60D=60 deg. |
| | | 700W | | 57K= 5700K | | |
| | | 1000W | | | | |
| | | 1200W | | | | |



CHOOSE THE ADAPTER FOR LED SHOEBOX



SLIP FITTER



ROUND POLE



RECTANGLE POLE



WALL MOUNT





CHOOSE POLE KITS

SPOKE BRACKET

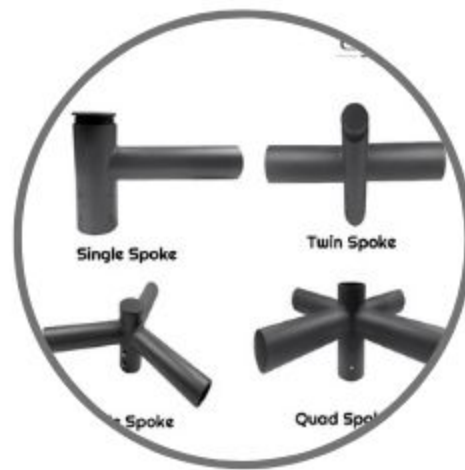

BULLHORN BRACKET

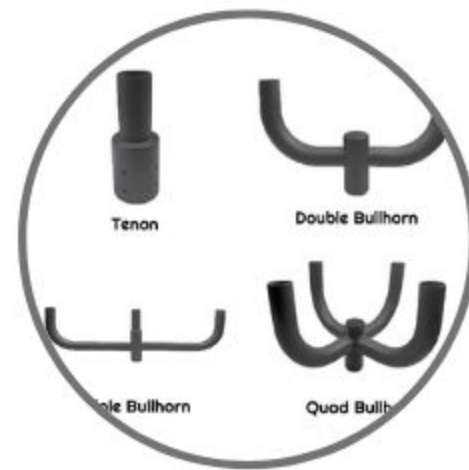

BULLHORN BRACKET



SQUARE POLE

Straight Square Steel Poles, 4", 5"

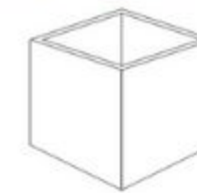

4" and 5" Square



P2
2 1/2" x 4" Tenon

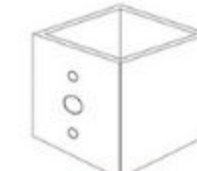

Side Drills:
2 at 180°, 4 at 90°



10-30 Feet

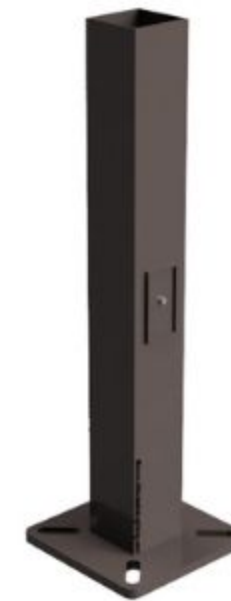

CHOOSE LIGHT DISTRIBUTION



Type II

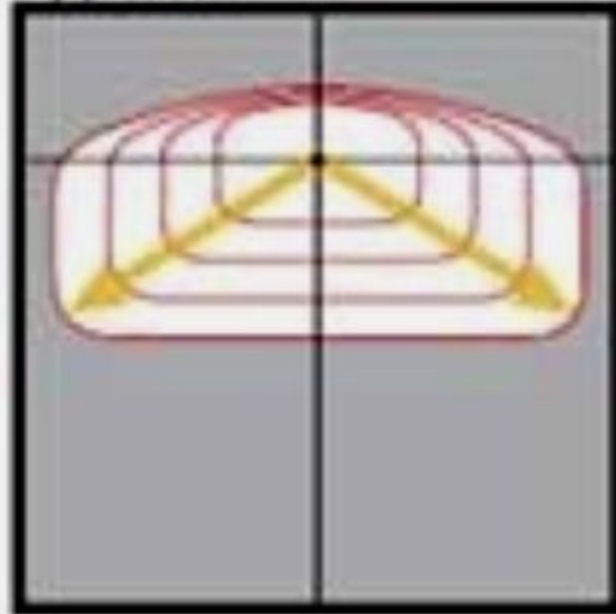

Type III

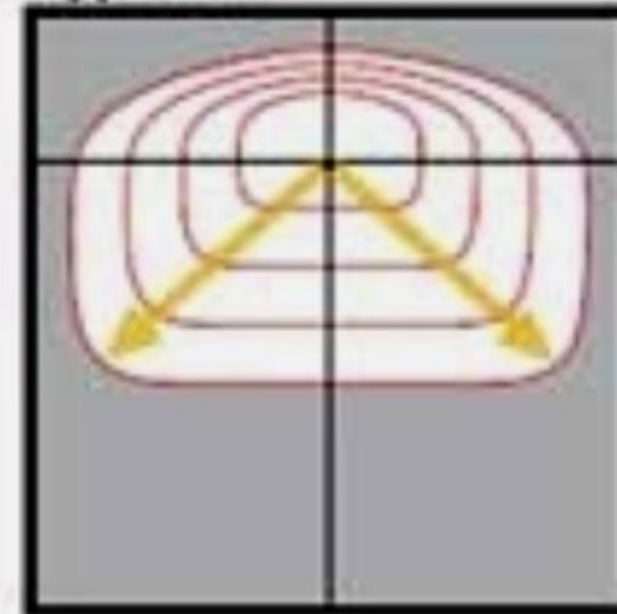

Type IV

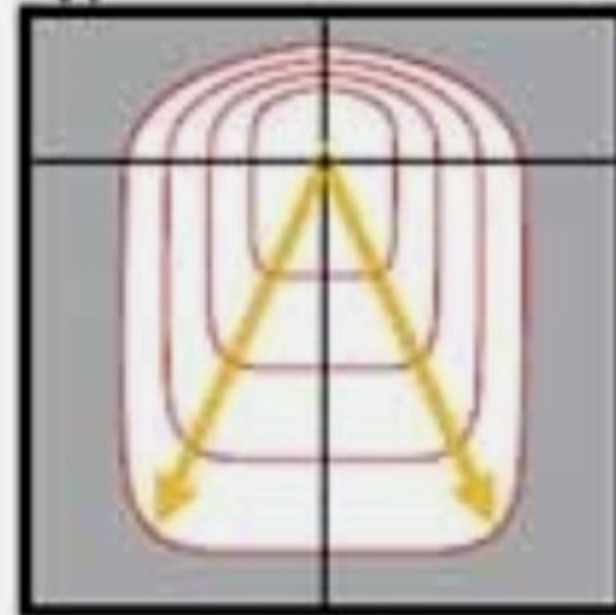

Type V

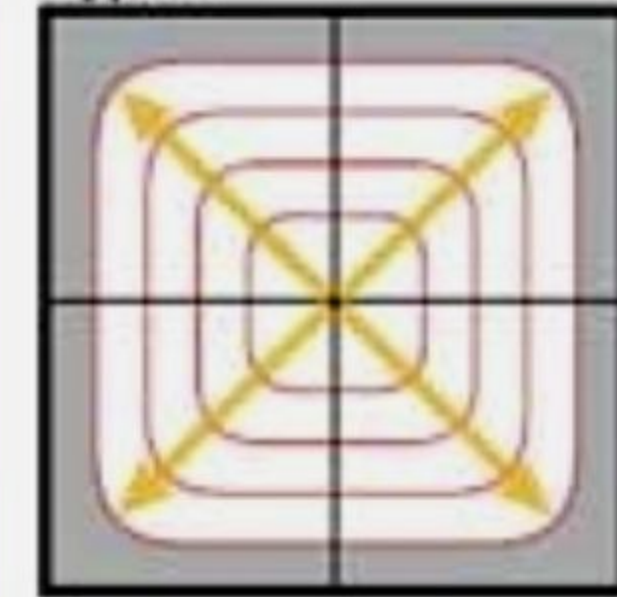



WATTAGE CHOICE



250 WATTS

HPS/ Metal Halide

EQUIVALENT



**10,000-12,000
LUMENS**

LED LIGHTS



400 WATTS

HPS/ Metal Halide

EQUIVALENT



**15,000-25,000
LUMENS**

LED LIGHTS



1,000 WATTS

HPS/ Metal Halide

EQUIVALENT



**36,000-55,000
LUMENS**

LED LIGHTS





US INVENTORY

Our FL & GA warehousing services enable your business to run at peak efficiency.



DLC QPL

Meet with Std. UL1598, CAN/CSA -C.22.2 NO. 250.0, EN61347, EN60598



WARRANTY

The complete fixture offers 5 years warranty, including the case, led chip, driver, and cable.

LET'S WORK TOGETHER



Shenzhen, Guangdong, China



+86-755-8383-7000



www.lightideled.com



sales@lightideled.com



A background image showing a business meeting. Two people in suits are shaking hands over a desk. On the desk, there are papers with charts, a laptop, and a tablet. One person is giving a thumbs up gesture. The image is dimmed with a dark overlay.

Thank You

We are looking forward to hearing from you soon.

www.lightideled.com

